



Light and transparency are the true stars of this project. We have always liked to think heretically, evoking mystery, magic and seduction. Magia is the new modular suspension lighting system that can be adapted to suit the different heights of the rooms and can generate direct and indirect light with the 360° adjustable module.

In this case, the lens is not used to focus, but to modify the vision and perception of the object.

The effect of the convex lens conceals the part of the light beam and produces the lightest effect of suspension and inconsistency. Luminaire designed also to be powered by ENDLESS conductive tape.

Archiproducts Design Award 2023

La luce e la trasparenza sono le vere protagoniste di questo progetto. Da sempre ci piace pensare in modo eretico, evocando mistero, magia e seduzione.

Magia è il nuovo sistema d'illuminazione a sospensione componibile e adattabile a seconda delle diverse altezze degli ambienti che può generare luce diretta e indiretta con il modulo orientabile a 360°.

In questo caso, la lente non è usata per focalizzare, ma per modificare la visione e la percezione dell'oggetto. L'effetto della lente convessa permette di celare la parte di emissione della luce e produrre un leggerissimo effetto di sospensione e inconsistenza. Apparecchio illuminante alimentabile anche con il tape conduttivo ENDLESS.

Archiproducts Design Award 2023

Single installation with ceiling driver

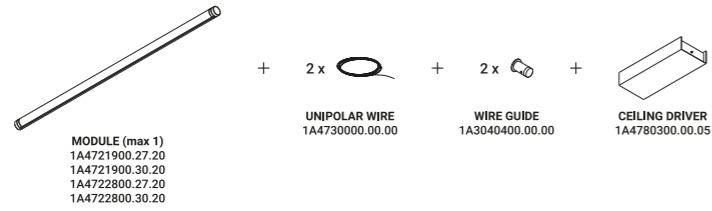

Multiple installation with ceiling driver

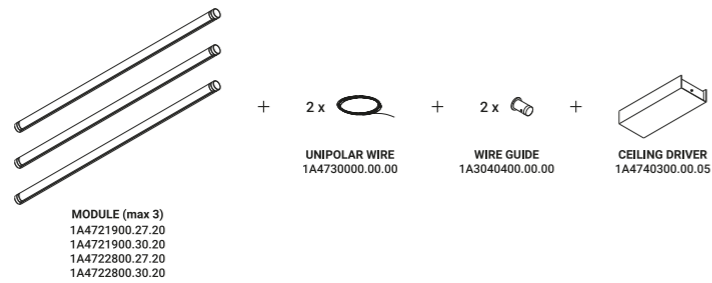

Single installation with recessed or ceiling suspension kit

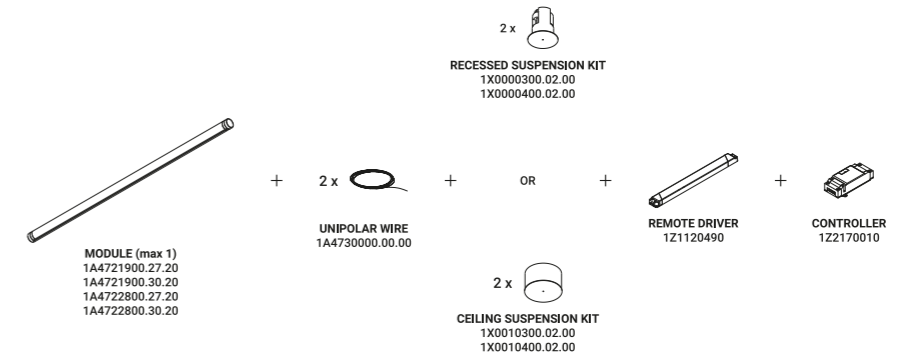

Multiple installation with recessed or ceiling suspension kit

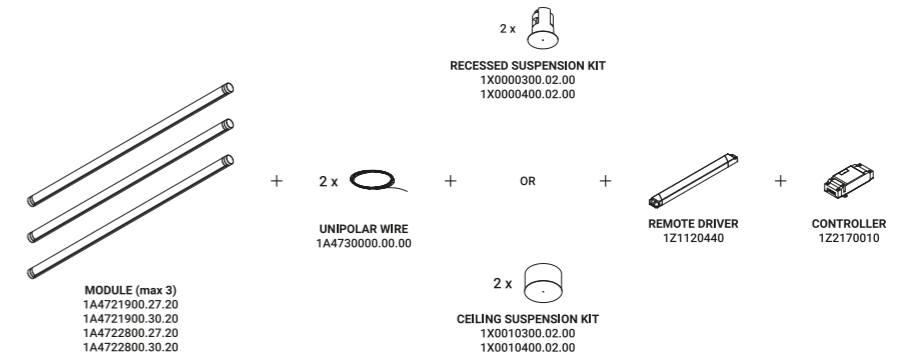

Suspension / Direct-Indirect / Indoor

Material	Metal - PMMA
Finish	.19 Polished Gold .28 Polished Black Chrome

Note Modular suspension luminaire. Adjustable along the horizontal axis. Transparent bar with refractive effect. LED module profile with matt black finish. Details with polished gold or black chrome finish. Matt white rose. Possibility for the luminaire to be powered by ENDLESS conductive tape and by dedicated voltage/current (Max 48V DC - Max 150W - Max 4A).

Apparecchio illuminante a sospensione componibile. Orientabile lungo l'asse orizzontale. Barra trasparente con effetto rifrattivo. Profilo del modulo LED con finitura nero opaco. Dettagli con finitura oro lucido o cromo nero. Rosone bianco opaco. Alimentabile anche con il tape conduttivo ENDLESS e tensione/corrente dedicata (Max 48V DC - Max 150W - Max 4A).

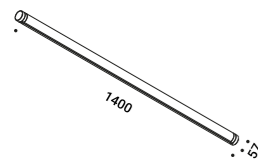
**MAGIA - MODULE**

19W
24V DC
2700K - 1272lm / 3000K - 1312lm
CRI >90
Driver not included



Polished Gold - 2700K
Polished Gold - 3000K
Polished Black Chrome - 2700K
Polished Black Chrome - 3000K

1A4721900.27.20
1A4721900.30.20
1A4722800.27.20
1A4722800.30.20

Compulsory accessories / Accessori obbligatori

Installation kits / Kit d'installazione

**Wire guide / Guidacavo**

Matt Black	1 Piece		Not included
------------	---------	--	--------------

		1A3040400.00.00	
--	--	-----------------	--

**Unipolar wire - 6 m / Cavo unipolare - 6 m**

1 Piece - Max 60V DC	Max 3 modules		Not included
----------------------	---------------	--	--------------

		1A4730000.00.00	
--	--	-----------------	--

Suspension kits / Kit di sospensione

**Recessed suspension kit for 12,5 mm plasterboard / Kit di sospensione da incasso per cartongesso 12,5 mm**

Matt White	For electrical cables - 1 Piece Plasterboard cut-out Ø 44 mm Minimum space for mounting 70 mm	1X0000300.02.00	Not included
------------	---	-----------------	--------------

Matt Black	For electrical cables - 1 Piece Plasterboard cut-out Ø 44 mm Minimum space for mounting 70 mm	1X0000400.02.00	
------------	---	-----------------	--

**Ceiling suspension kit / Kit di sospensione da soffitto**

Matt White	For electrical cables - 1 Piece	1X0010300.02.00	Not included
------------	---------------------------------	-----------------	--------------

Matt Black	For electrical cables - 1 Piece	1X0010400.02.00	
------------	---------------------------------	-----------------	--

The sizes are expressed in millimeters.

Compulsory accessories / Accessori obbligatori

Drivers / Alimentatori

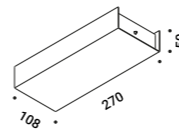
**Ceiling driver / Driver da soffitto**

Matt White	Input 220-240V - 50/60Hz Output 24V - 21W - IP20 DALI - PUSH - 1-10V - TRIAC	Max 1 module	1A4780300.00.05	Not included
------------	--	--------------	-----------------	--------------

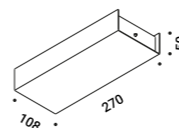
**Ceiling driver / Driver da soffitto**

Matt White	Input 120-240V - 50/60Hz Output 24V - 60W - IP20 DALI - PUSH - 1-10V - TRIAC	Max 3 modules	1A4740300.00.05	Not included
------------	--	---------------	-----------------	--------------

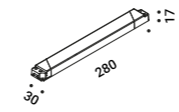
**Driver / Alimentatore**

100-240V	24V/50W/IP20/ON/OFF	Max 1 module	1Z1120490	Not included
----------	---------------------	--------------	-----------	--------------

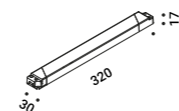
**Driver / Alimentatore**

100-240V	24V/80W/IP20/ON/OFF	Max 3 modules	1Z1120440	Not included
----------	---------------------	---------------	-----------	--------------

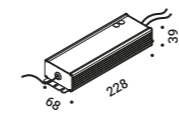
**Driver / Alimentatore**

100-240V	24V/150W/IP67/1-10V	Max 6 modules	1Z1120500	Not included
----------	---------------------	---------------	-----------	--------------

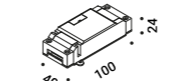
**Controller**

	DALI - PUSH - 0/1-10V - TRIAC - IP20		1Z2170010	Not included
--	--------------------------------------	--	-----------	--------------

Optional accessories / Accessori opzionali

Suspension kits / Kit di sospensione

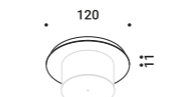
**Wall adapter plate / Piastra di adattamento da parete**

Matt White	For mounting on brick masonry walls		1X0050300.01.00	Not included
------------	-------------------------------------	--	-----------------	--------------

SUSPENSION KITS / KIT DI SOSPENSIONE

Recessed suspension kit / Kit di sospensione da incasso

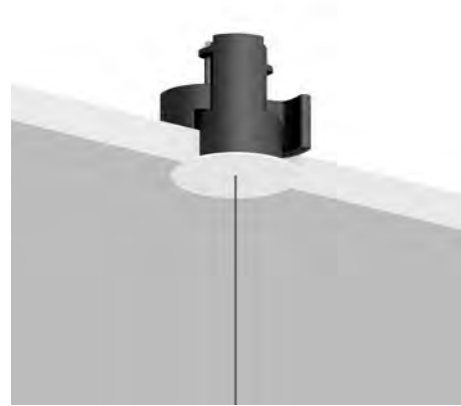

Suspension kit for 12,5 mm plasterboard
Plasterboard cut-out Ø 44 mm
Minimum space for mounting 70 mm

Kit di sospensione per cartongesso 12,5 mm
Dimensioni taglio cartongesso Ø 44 mm
Spazio minimo per incasso 70 mm

Magnetic fixing
Fissaggio magnetico



Version	Use	Product reference	Finish	Code
Recessed suspension kit.01	For suspension cables	REFLEX S 1	Matt White	1X0000300.01.00
		REFLEX S 2		
		SHANGHAI 1		
		SHANGHAI 2	Matt Black	
		SOTTILE 1		
		SOTTILE 1 DE		
Recessed suspension kit.02	For electrical cables	MAGIA	Matt White	1X0000300.02.00
			Matt Black	1X0000400.02.00
Recessed suspension kit.03	For suspension cables	MASAI 1	Matt White	1X0000300.03.00
		MASAI 2	Matt Black	1X0000400.03.00
		SPY DE		
Recessed suspension kit.04	For electrical cables	ASINTOTO	Matt White	1X0000300.04.00
		REFLEX S 2	Matt Black	1X0000400.04.00
		SHANGHAI 2		
Recessed suspension kit.05	For electrical cables	LOUIS XIV 2	Matt White	1X0000300.05.00
		SOTTOSOPRA 2	Matt Black	1X0000400.05.00

SUSPENSION KITS / KIT DI SOSPENSIONE

Ceiling suspension kit / Kit di sospensione da soffitto

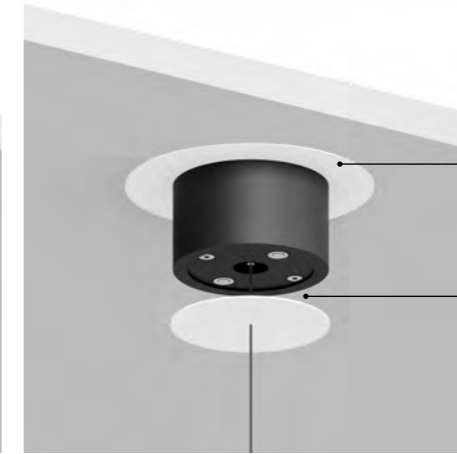

Back plate for masonry ceilings
Back plate per soffitti in muratura

Magnetic fixing
Fissaggio magnetico



Version	Use	Product reference	Finish	Code
Ceiling suspension kit.01	For suspension cables	REFLEX S 1	Matt White	1X0010300.01.00
		REFLEX S 2		
		SHANGHAI 1		
		SHANGHAI 2	Matt Black	
		SOTTILE 1		
		SOTTILE 1 DE		
Ceiling suspension kit.02	For electrical cables	MAGIA	Matt White	1X0010300.02.00
			Matt Black	1X0010400.02.00
Ceiling suspension kit.03	For suspension cables	MASAI 1	Matt White	1X0010300.03.00
		MASAI 2	Matt Black	1X0010400.03.00
		SPY DE		
Ceiling suspension kit.04	For electrical cables	ASINTOTO	Matt White	1X0010300.04.00
		REFLEX S 2	Matt Black	1X0010400.04.00
		SHANGHAI 2		
Back plate	For masonry ceilings		Matt White	1X0050300.01.00

